

SAMSUNG TECHWIN

Supreme Resolution WDR Camera

User Manual

SCB-5003



SAMSUNG

CE

SAMSUNG

Supreme Resolution WDR Camera

User Manual

Copyright

©2014 Samsung Techwin Co., Ltd. All rights reserved.

Trademark

SAMSUNG TECHWIN  is the registered logo of Samsung Techwin Co., Ltd.

The name of this product is the registered trademark of Samsung Techwin Co., Ltd.

Other trademarks mentioned in this manual are the registered trademark of their respective company.

Restriction

Samsung Techwin Co., Ltd shall reserve the copyright of this document. Under no circumstances, this document shall be reproduced, distributed or changed, partially or wholly, without formal authorization of Samsung Techwin.

Disclaimer

Samsung Techwin makes the best to verify the integrity and correctness of the contents in this document, but no formal guarantee shall be provided. Use of this document and the subsequent results shall be entirely on the user's own responsibility. Samsung Techwin reserves the right to change the contents of this document without prior notice.

Warranty

If the product does not operate properly in normal conditions, please let us know. Samsung Techwin will resolve the problem for free of charge. The warranty period is 3 years. However, the followings are excluded:

- If the system behaves abnormally because you run a program irrelevant to the system operation.
- Deteriorated performance or natural worn-out in process of time
- ❖ Design and specifications are subject to change without prior notice.

Before operating the camera, confirm the camera model and correct input power voltage. To help you understand this manual thoroughly, we'll introduce our model description.

■ SCB-5003 SERIES

- NTSC MODEL
SCB-5003N
- PAL MODEL
SCB-5003P

■ MODEL DESCRIPTION

- SCB-5003X



- SIGNAL SYSTEM
N → NTSC MODEL
P → PAL MODEL

safety information



CAUTION

RISK OF ELECTRIC SHOCK.
DO NOT OPEN



CAUTION: TO REDUCE THE RISK OF ELECTRIC SHOCK, DO NOT REMOVE COVER (OR BACK) NO USER SERVICEABLE PARTS INSIDE. REFER SERVICING TO QUALIFIED SERVICE PERSONNEL.



This symbol indicates that dangerous voltage consisting a risk of electric shock is present within this unit.



This exclamation point symbol is intended to alert the user to the presence of important operating and maintenance (servicing) instructions in the literature accompanying the appliance.

WARNING

- To prevent damage which may result in fire or electric shock hazard, do not expose this appliance to rain or moisture.
- To prevent injury, this apparatus must be securely attached to the floor/wall in accordance with the installation instructions.

WARNING

1. Be sure to use only the standard adapter that is specified in the specification sheet. Using any other adapter could cause fire, electrical shock, or damage to the product.
2. Incorrectly connecting the power supply or replacing battery may cause explosion, fire, electric shock, or damage to the product.
3. Do not connect multiple cameras to a single adapter. Exceeding the capacity may cause abnormal heat generation or fire.
4. Securely plug the power cord into the power receptacle. insecure connection may cause fire.
5. When installing the camera, fasten it securely and firmly. The fall of camera may cause personal injury.

6. Do not place conductive objects (e.g. screwdrivers, coins, metal parts, etc.) or containers filled with water on top of the camera. doing so may cause personal injury due to fire, electric shock, or falling objects.
7. Do not install the unit in humid, dusty, or sooty locations. doing so may cause fire or electric shock.
8. If any unusual smells or smoke come from the unit, stop using the product. in such case, immediately disconnect the power source and contact the service center. continued use in such a condition may cause fire or electric shock.
9. If this product fails to operate normally, contact the nearest service center. never disassemble or modify this product in any way. (samsung is not liable for problems caused by unauthorized modifications or attempted repair.)
10. When cleaning, do not spray water directly onto parts of the product. doing so may cause fire or electric shock.

CAUTION

1. Do not drop objects on the product or apply strong shock to it. Keep away from a location subject to excessive vibration or magnetic interference.
2. Do not install in a location subject to high temperature (over 55°C), low temperature (below -10°C), or high humidity. Doing so may cause fire or electric shock.
3. If you want to relocate the already installed product, be sure to turn off the power and then move or reinstall it.
4. Remove the power plug from the outlet when there is a lightning. Neglecting to do so may cause fire or damage to the product.
5. Keep out of direct sunlight and heat radiation sources. It may cause fire.
6. Install it in a place with good ventilation.
7. Avoid aiming the camera directly towards extremely bright objects such as sun, as this may damage the CMOS image sensor.
8. Apparatus shall not be exposed to dripping or splashing and no objects filled with liquids, such as vases, shall be placed on the apparatus.
9. The Mains plug is used as a disconnect device and shall stay readily operable at any time.
10. Do not expose the camera to radioactivity. Radioactivity exposure may damage the CMOS.

safety information

FCC Statement

This device complies with part 15 of the FCC Rules. Operation is subject to the following two conditions :

- 1) This device may not cause harmful interference, and
- 2) This device must accept any interference received including interference that may cause undesired operation.

CAUTION

This equipment has been tested and found to comply with the limits for a Class A digital device, pursuant to part 15 of FCC Rules. These limits are designed to provide reasonable protection against harmful interference when the equipment is operated in a commercial environment. This equipment generates, uses, and can radiate radio frequency energy and, if not installed and used in accordance with the instruction manual, may cause harmful interference to radio communications. Operation of this equipment in a residential area is likely to cause harmful interference in which case the user will be required to correct the interference at his own expense.



IC Compliance Notice

This Class A digital apparatus meets all requirements of the Canadian Interference.-Causing Equipment Regulations of ICES-003.



Correct Disposal of This Product (Waste Electrical & Electronic Equipment)

(Applicable in the European Union and other European countries with separate collection systems)

This marking on the product, accessories or literature indicates that the product and its electronic accessories (e.g. charger, headset, USB cable) should not be disposed of with other household waste at the end of their working life. To prevent possible harm to the environment or human health from uncontrolled waste disposal, please separate these items from other types of waste and recycle them responsibly to promote the sustainable reuse of material resources.

Household users should contact either the retailer where they purchased this product, or their local government office, for details of where and how they can take these items for environmentally safe recycling.

Business users should contact their supplier and check the terms and conditions of the purchase contract. This product and its electronic accessories should not be mixed with other commercial wastes for disposal.



Correct disposal of batteries in this product

(Applicable in the European Union and other European countries with separate battery return systems.)

This marking on the battery, manual or packaging indicates that the batteries in this product should not be disposed of with other household waste at the end of their working life. Where marked, the chemical symbols Hg, Cd or Pb indicate that the battery contains mercury, cadmium or lead above the reference levels in EC Directive 2006/66. If batteries are not properly disposed of, these substances can cause harm to human health or the environment.

To protect natural resources and to promote material reuse, please separate batteries from other types of waste and recycle them through your local, free battery return system.

important safety instructions

1. Read these instructions.
2. Keep these instructions.
3. Heed all warnings.
4. Follow all instructions.
5. Do not use this apparatus near water.
6. Clean only with dry cloth.
7. Do not block any ventilation openings. Install in accordance with the manufacturer's instructions.
8. Do not install near any heat sources such as radiators, heat registers, or other apparatus (including amplifiers) that produce heat.
9. Do not defeat the safety purpose of the polarized or grounding-type plug. A polarized plug has two blades with one wider than the other. A grounding type plug has two blades and a third grounding prong. The wide blade or the third prong is provided for your safety. If the provided plug does not fit into your outlet, consult an electrician for replacement of the obsolete outlet.
10. Protect the power cord from being walked on or pinched particularly at plugs, convenience receptacles, and the point where they exit from the apparatus.
11. Only use attachments/accessories specified by the manufacturer.
12. Use only with cart, stand, tripod, bracket, or table specified by the manufacturer, or sold with the apparatus.
13. Unplug this apparatus when a card is used. Use caution when moving the cart/ apparatus combination to avoid injury from tip-over.
14. Refer all servicing to qualified service personnel. Servicing is required when the apparatus has been damaged in any way, such as powersupply cord or plug is damaged, liquid has been spilled or objects have fallen into the apparatus, the apparatus has been exposed to rain or moisture, does not operate normally, or has been dropped.



Apparatus shall not be exposed to dripping or splashing and no objects filled with liquids, such as vases, shall be placed on the apparatus



Samsung Techwin cares for the environment at all product manufacturing stages to preserve the environment, and is taking a number of steps to provide customers with more environment-friendly products. The Eco mark represents Samsung Techwin's will to create environment-friendly products, and indicates that the product satisfies the EU RoHS Directive.

contents

INTRODUCTION

9

- 9 Features
- 10 Components and Accessories
- 11 Overview
- 13 Lens

CONNECTION

16

- 16 Connecting to Monitor
- 16 Connecting to Power
- 17 Control via RS-485 Interface
- 18 Using Coaxial Communications

CAMERA OPERATION

19

- 19 Menu Configuration
- 19 Menu Setup

TROUBLESHOOTING

36

- 36 Troubleshooting

SPECIFICATIONS

37

- 37 Specifications
- 39 Dimension

FEATURES

- **High Resolution**

Use of a 1.4 mega pixel CMOS device provides clear pictures with a horizontal resolution of 1000.

- **Excellent Sensitivity**

The built-in high sensitivity COLOR CMOS produces a clear image.

- Color : 0.03Lux (F1.2, 50IRE), 0.001Lux (1sec, F1.2, 50IRE)
0.01Lux (F1.2, 30IRE), 0.0003Lux (1sec, F1.2, 30IRE)
- B/W : 0.003Lux (F1.2, 50IRE), 0.0001Lux (1sec, F1.2, 50IRE)
0.001Lux (F1.2, 30IRE), 0.00003Lux (1sec, F1.2, 30IRE)

- **Intelligence**

Without an external sensor, you can use this product to detect motion and generate alarms and thus more efficient monitoring can be achieved.

- **SSNR4 (Samsung Super Noise Reduction) Function**

High performance W7 Chip removes noises of GAIN resulting from the low light level and shows a vivid, high definition video even in the dark place.

- **Day&Night**

This camera has a function that automatically selects the mode that is appropriate for daytime or night-time conditions. The COLOR mode operates in daytime conditions to provide optimum colors, and B/W mode operates in night-time conditions to enhance the definition of the image.

- **SSDR (Samsung Super Dynamic Range)**

If an object has a large variance between bright and dark areas, it will keep bright areas bright and make selected dark areas bright, so that the overall brightness can be maintained.

- **PROFILE**

You can set a mode according to the camera installation conditions.

- BASIC, DAYNIGHT, BACKLIGHT, ITS, INDOOR, USER

- **WDR**

By adopting a proprietary W7 chip, the camera delivers clear, high quality pictures even in backlight, by increasing exposure in dark areas while decreasing it in bright areas; a corrected image with clear details results.

introduction

- **Video/DC Drive Lens Support**

You can select Video or DC Drive Lens from the menu.

- **DIS (Digital Image Stabilizer)**

The DIS function compensates for any camera movement, to produce more stable pictures.

- **Miscellaneous Functions**

HLC(High Light Compensation), REVERSE , D-ZOOM, SHARPNESS and PRIVACY functions are provided.

- **Communication**

Coaxial and RS-485 communication methods are supported.

- Coaxial Communications : Pelco Coaxitron

- RS-485 Communications : Samsung-T, Samsung-E, PELCO-D, PELCO-P, BOSCH, HONEYWELL, VICON, PANASONIC, GE, AD

- **OSD**

The camera's OSD is complimented by 17 languages.

- English, Japanese, Spanish, French, Portuguese, Korean, German, Italian, Chinese, Russian, Polish, Czech, Romanian, Serbian, Swedish, Danish, Turkish.

COMPONENTS AND ACCESSORIES

Check if the following items are included in the product package.

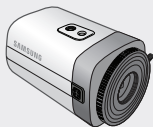

SCB-5003



Quick Manual

OVERVIEW

Front View

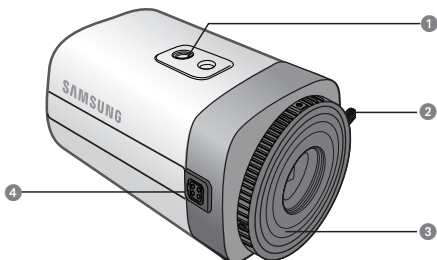

1 Tripod Mounting Bracket Screw Hole :

- Used to fix the camera on a bracket.
The screw sizes for this hole are as follows.
1/4"-20 UNC (20 THREAD)
L:4.5mm±0.2mm (ISO standard), or 0.197"
(ASA standard)

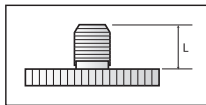

2 Back Focus Control Lever : It acquires margins for lens adjustments.

3 Lens adaptor : Install this if you use the lens.

4 Auto Iris Lens Connector : Used to connect Auto Iris Lens plug.



- Auto shutter adaptor, c-mount adaptor and supporting board are not provided with the camera. Please check the installed documentation of tripod for the installation of cameras.

Rear View

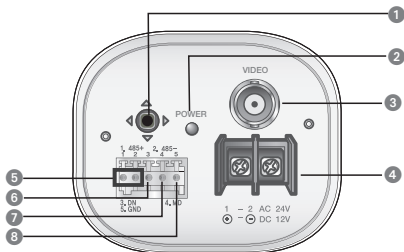

1 Function Setup switch

Display the menu on the screen and move the cursor to four directions to confirm status or after changing a selected item.

2 Power LED : This lamp is lit when the camera is receiving power normally.

3 Video OUT Terminal : Sends video signal and connects to the video input terminal of the monitor.

4 Power input terminal : Connect the designated power supplies.

5 RS-485 Control Port : You can control SETUP MENU through this port by using external controllers like a Remote controller that RS-485 Communication is supported.

6 D & N Input Port : You can switch to Day & Night Mode by connecting an external signal to this port.

7 MD Output Port : Motion detection signals are output through this port.

8 Ground terminal

※ External I / O port configuration

Num	Name	I/O Direction
1	RS-485+	I/O
2	RS-485-	I/O
3	DN	I
4	MD	O
5	GND	-

LENS

The lens is not supplied with this camera. Purchase a lens suitable for your environment. This camera accepts the auto iris lens and both C-and CS-mount lens.



- To use the functions of this camera effectively it is recommended that a DC type Auto Iris lens is used.
- Keep the lens surface clean, if it becomes contaminated with dirt or fingerprints the picture quality suffers.

When Using Auto Iris Lens

1. Strip the insulation of the auto iris lens cable 8mm from the end.

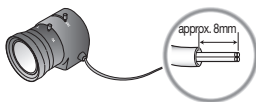

2. Strip the insulation of the core of the auto iris lens cable to expose a 2mm length.

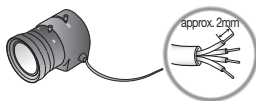

3. Remove the cover of the auto iris lens connector plug and solder the lens cable to the connector pin of the plug.

Pin No.	LENS	
	DC	VIDEO
No.1 Pin	Damping -	Red (power)
No.2 Pin	Damping +	NC
No.3 Pin	Drive +	White (video signal)
No.4 Pin	Drive -	Black (GND)

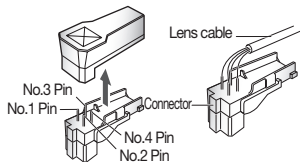

4. Fit the cover of the auto iris lens connector plug, remove the protective glass cover from the front of the camera, and fasten the auto iris lens by turning it clockwise.

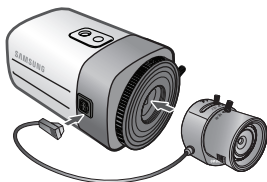

5. After combining the lens, adjust the focus.

When Using a C/CS-Mount lens (Sold separately)

Before installing a lens, identify whether the lens to be installed is a C-Mount or CS-Mount. This camera is set for a CS-Mount Lens by default. To install a C-Mount Lens, a simple modification is required.

- **When Using a CS-Mount Lens**
Remove the protective glass cover at the front of this product and turn the CS-Mount Lens clockwise to install it.

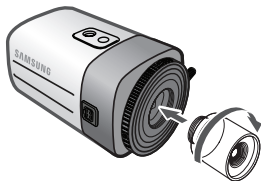



- Use the lens connector shown in the following figure. If the dimensions of the connector are not correct, it may damage the camera, or the lens may not be installed firmly.
- If the lens is too heavy, the camera becomes unbalanced and there may be problems. Use a lens that weighs less than 450g.
- When adjusting the Automatic Level Control (ALC) of an auto iris lens, use Av mode if available. If you use the Pk mode, the picture brightness may change continuously.

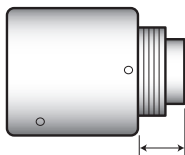

C-Mount Lens: 10mm or less
CS-Mount Lens: 5mm or less

• When Using a C-Mount Lens

1. Remove the protective glass cover at the front of this product and turn the C-Mount Adapter clockwise to install it.

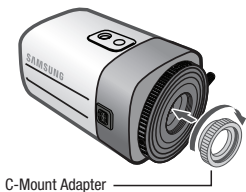

2. Turn the C-Mount lens clockwise to install it.

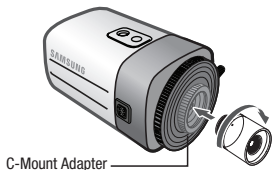

3. After combining the lens, adjust the focus.

CONNECTING TO MONITOR

Connect the Video OUT port on the rear panel of the camera to a monitor.

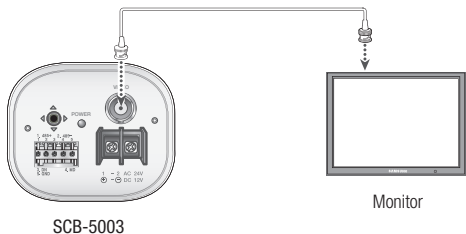

- As the connecting method varies with the instruments, refer to the manual supplied with the instrument.
- Only connect the cable when the power is turned off.

CONNECTING TO POWER

You can connect power as shown in the following figure.

Since the power specification supports both AC and DC, connect AC 24V, 500mA Adaptor or DC 12V, 500mA Adaptor.

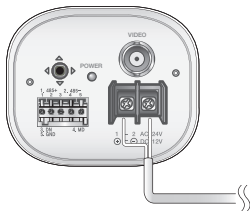

When the resistance value of copper wire is at [20°C(68°F)]

Copper wire size (AWG)	#24 (0.22mm ²)	#22 (0.33mm ²)	#20 (0.52mm ²)	#18 (0.83mm ²)
Resistance value(Ω/m)	0.078	0.050	0.030	0.018
Voltage Drop (V/m)	0.028	0.018	0.011	0.006

- As shown in the table above, voltage decreases as the wire gets longer. Therefore use of an excessively long adaptor output line for connection to the camera may affect the performance of the camera.
- ※ Standard voltage for camera operation : DC 12V±10%, AC 24V±10%
- ※ There may be some deviation in voltage drop depending on the type of wire and the manufacturer.



- Be sure to connect power only after all the installation is complete.

CONTROL VIA RS-485 INTERFACE

The camera can be controlled by using external controllers like a Remote controller. (RS-485 Communication)

(1) To control by PC

Connect the RS-485 control port of the camera and the serial cable through an RS-485 converter.

Example) PC Serial Port (COM1) → Serial Cable → RS-485 Converter → Camera RS-485 Control Port.

(2) To control using a DVR or System Controller

Connect the RS-485 cable (TRX+, TRX-) to the connection port of the 485 control board that is connected to the DVR or System Controller.

485 Control Board Connection Port	RS-485 Control Port
(+) CONNECTION TERMINAL (TRX+)	485+
(-) CONNECTION TERMINAL (TRX-)	485-

* RS-485 Communication establishment initial value

Item	Camera ID	BAUD RATE	UART MODE	RET PKT
Initial value	1	9600	8-NONE-1	ENABLE



- To control the camera by constructing an additional controller, use the SAMSUNG-T, SAMSUNG-E, PELCO-D, PELCO-P, BOSCH, HONEYWELL, VICON and PANASONIC, GE, AD protocol.

USING COAXIAL COMMUNICATIONS

- Coaxial Communications System
- OSD Control method

CAMERA	DVR	CONTROLLER
SET	MENU/ENTER	OSD KEY
UP	UP KEY	JOYSTICK UP
DOWN	DOWN KEY	JOYSTICK DOWN
LEFT	LEFT KEY	JOYSTICK LEFT
RIGHT	RIGHT KEY	JOYSTICK RIGHT

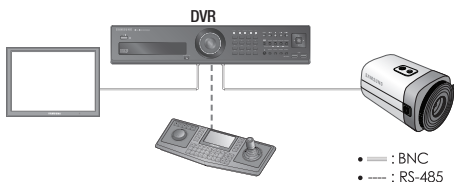

- Video Cable

The camera's video output port is connected to the monitor with a BNC coaxial cable, shown below. If the distance between the camera and the monitor exceeds the recommended maximum, please use an auxiliary video amp.

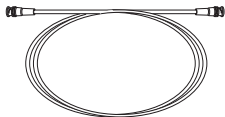

Distance	Recommended Cable Specification
300m	3C2V(RG-59/U)
450m	5C2V(RG-6/U)
600m	7C2V(RG-11/U)



- It is recommended that pure copper coax cable is used and not copper coated steel, as this will cause issues with the communication over the coaxial cable.

MENU CONFIGURATION

MAIN SETUP			
PROFILE	● BASIC ● ITS	● DAY/NIGHT ● INDOOR	● BACKLIGHT ● USER
SSDR	● ON	● OFF	
WHITE BAL	● ATW ● MANUAL	● OUTDOOR ● AWC → SET	● INDOOR ● MERCURY
EXPOSURE	● BRIGHTNESS ● AGC	● LENS ● SSNR4	● SHUTTER ● RETURN
BACKLIGHT	● OFF ● WDR	● USER BLC	● HLC
SPECIAL	● DISPLAY ● DAY/NIGHT ● DIS	● COMM ADJ ● DEFOG ● VIDEO ANALYTICS	● IMAGE ADJ ● PRIVACY ● RETURN
EXIT	● SAVE	● NOT SAVE	● RESET

MENU SETUP

Use the Function Setup switch within the camera.

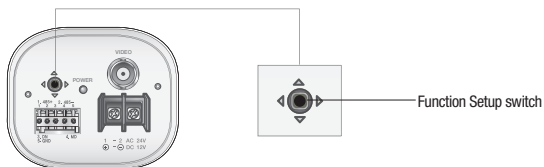

camera operation

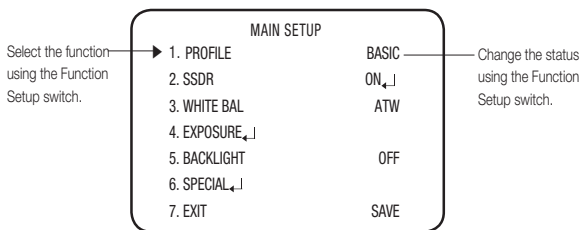

1. Press the Function Setup switch.
 - Main SETUP menu is displayed on the monitor screen.
2. Select a desired function using the Function Setup switch.
 - Place the cursor over a desired item.
3. Set up a selected item by using the Function Setup switch.
4. To finish the setting, select 'EXIT' and press the Function Setup switch.



- An item with the ◀ ↓ icon also has sub menus. To select a sub menu, select an item with the icon and press the Function Setup switch.
- An item with the --- icon is unavailable due to function settings.

PROFILE

1. When the SETUP menu screen is displayed, select 'PROFILE' by using the Function Setup switch so that the arrow indicates 'PROFILE'.

2. Select a desired mode using the Function Setup switch according to the picture display you want.

- **BASIC** : The most common environment is set to meet.
- **DAY/NIGHT** : It will be set automatically so it optimizes to the day or night conditions, respectively.
- **BACKLIGHT** : It will be set automatically so you can distinguish the object from the background in a severe backlighting scene.
- **ITS** : It will be set automatically so you can easily check the traffic conditions.

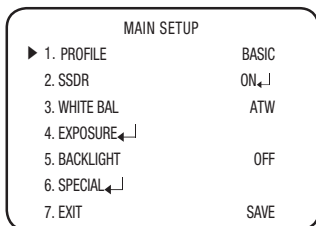

- **INDOOR** : It will be set automatically to help you take a picture in a regular indoor lighting condition.
- **USER** : Automatically configures the camera to your custom settings.
 - 1) Select Custom for Simple Setup mode.
 - 2) Configure the menu options to your custom settings.
 - 3) The settings are automatically saved as Custom mode.
 - 4) Profile user mode don't initialize when menu resets.

3. In the PROFILE menu, you can configure the following camera settings at once.

	BASIC	DAY/NIGHT	BACKLIGHT	ITS	INDOOR	USER
SHUTTER	ATW	ATW	ATW	MANUAL(1/200)	A.FLK	-
AGC	HIGH	HIGH	HIGH	HIGH	HIGH	-
WHITE BAL	ATW	ATW	ATW	OUTDOOR	INDOOR	-
BACKLIGHT	OFF	OFF	USER BLC	OFF	OFF	-
SSNR4	ON	ON	ON	ON	ON	-
DAY/NIGHT	AUTO	AUTO	AUTO	AUTO	AUTO	-



- If you select the traffic monitoring mode, the shutter will be set to 1/200 sec. Noise can be detected at night.

SSDR (Samsung Super Dynamic Range)

If an object has a large variance between bright and dark areas, it will keep bright areas bright and make selected dark areas bright, so that the overall brightness can be maintained.

1. When the SETUP menu screen is displayed, select 'SSDR' by using the Function Setup switch so that the arrow indicates 'SSDR'.
2. Use the Function Setup switch to change the SSDR level in the sub menu according to the contrast between bright and dark areas.

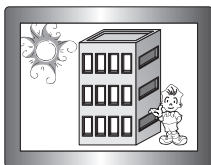

SSDR ON

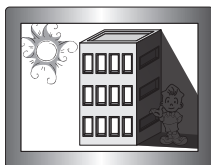

SSDR OFF

White Bal (White Balance)

Use the White Balance function to adjust the screen color.

1. When the SETUP menu screen is displayed, select 'White Bal' by using the Function Setup switch so that the arrow indicates 'White Bal'.
2. Select a desired mode using the Function Setup switch.

MAIN SETUP	
1. PROFILE	BASIC
2. SSSDR	ON _← ↓
▶ 3. WHITE BAL	ATW

※ Select one of the following 6 modes, as appropriate for your purpose.

- **ATW** : Select this when the color temperature is between 1,800°K and 10,500°K.
- **OUTDOOR** : Use it in a color temperature range of 1,800K to 10,500K.(including Natrium). Auto adjustment is made to optimize the camera color to the outdoor environment.
- **INDOOR** : Select this when the color temperature is between 4,500°K and 8,500°K. Automatically adjusts the camera color for optimization to the indoor environment.

- **MANUAL** : Select this to fine-tune White Balance manually. Set White Balance first by using the ATW or AWC mode. After that button to MANUAL mode, fine-tune the White Balance and the Function Setup switch.

WB MANUAL	
▶ 1. RED GAIN	--*----- 485
2. BLUE GAIN	--*----- 535
3. RETURN _← ↓	

- **AWC→SET** : To find the optimal luminance level for the current environment, point the camera towards a sheet of white paper and press the Function Setup switch. If the environment changes, readjust it.
- **Mercury** : This is an auto compensation function that optimizes camera colors for the environments such as mercury lamps.



- White Balance may not work properly under the following conditions. In this case select the AWC mode.
 - ① Select this When the color temperature of environment surrounding the subject is out of the control range (e.g. clear sky, or sunset)
 - ② When the ambient illumination of the subject is dim.
- If the camera is directed towards a fluorescent light or is installed in a place where illumination changes dramatically, the White Balance operation may become unstable.

EXPOSURE

- When the SETUP menu screen is displayed, select 'EXPOSURE' by using the Function Setup switch so that the arrow indicates 'EXPOSURE'.
- Select a desired mode using the Function Setup switch.

- **BRIGHTNESS** : Adjusts the video brightness.
- **LENS** : Using this function, you can control the screen brightness.

EXPOSURE SETUP		
▶ 1. BRIGHTNESS	----*----	50
2. LENS		DC◀↓
3. SHUTTER◀↓		
4. AGC		HIGH
5. SSNR4		ON◀↓
6. RETURN◀↓		

- DC/VIDEO : Select Auto Iris Lens.
 - IRIS SPEED (DC) : Adjusts the Iris control speed of the DC lens. If the control speed is too slow or fast, please use this menu to adjust the speed.
 - Level (VIDEO) : Adjusts the level of video iris signals; the higher the level, the brighter the video looks.
 - FOCUS ADJ (DC/VIDEO) : To correctly adjust the focus of LENS, activate the focus setup mode located at the bottom of each lens menu.
- Manual : Select Manual Lens.



- When using VIDEO lens, adjust the lens VR explained below first and set the focus using 'FOCUS ADJ' menu.
- Some lenses may not work properly, depending on the setting of the BRIGHTNESS LEVEL.
- When Using a Video-Type Auto Iris Lens
 - Adjust the ALC adjustment terminal on the lens appropriately. In general, set it to AV (Average).
 - It may not work properly depending on the installed lens. Set the Level VR of the lens to the optimal value.
 - Set AGC to OFF and adjust the Lens VR to an appropriate brightness.
 - Adjust the Lens VR, adjust the BRIGHTNESS, and then check if the screen brightness changes properly. Otherwise, adjust the Lens VR again.
- ※ Lens' level VR may not operate depending on the type of lens.

camera operation

- **SHUTTER** : You can select the shutter.
 - MIN : 1 ~ 1/12000
 - MAX : 1/60 ~ 1/12000
 - A.FLK : Select this when you experience picture flicker, this happen when there is a clash with the installed lighting frequency.



- The greater the shutter value the brighter the screen is but the more the residual images of objects there are.
- If the min shutter value is large, it can cause noise, spots and white areas but still operate normally.
- If you do not use the AGC mode on the exposure menu, it cannot be set above 1/60sec.
- Depending on the setting range of the minimal/maximal shutter, the screen exposure can become saturated.

- **AGC (OFF/LOW/MIDDLE/HIGH)** : The higher the gain level, the brighter the screen - but the greater the noise.
- **SSNR4** : This function reduces the background noise in a low luminance environment.
 - OFF : Deactivates SSNR4. Noise is not reduced.
 - ON : Activates SSNR4 so that noise is reduced.



- When adjusting the noise reduction level in the SSNR4 mode, remember that the higher the level set, the more the noise level will be reduced, as will the brightness of the image.

BACKLIGHT

The camera uses our own W7 chips that are designed to clearly display the object and the background despite severe reverse light.

1. When the SETUP menu screen is displayed, select 'BACKLIGHT' by using the Function Setup switch. so that the arrow indicates 'BACKLIGHT'.
2. Select a desired mode using the Function Setup switch depending on the camera purpose.

- **USER BLC** :

Enables a user to select a desired area on a picture and view that area more clearly.

- LEVEL : Adjusts the brightness level of a monitoring area.
- TOP/BOTTOM/LEFT/RIGHT : Adjust the area to be enhanced.
- RETURN : Return to the MAIN SETUP menu.

BLC SETUP		
▶ 1. LEVEL		MIDDLE
2. TOP	--*----	30
3. BOTTOM	-----*	75
4. LEFT	--*----	30
5. RIGHT	-----*	75
6. RETURN	↓	

● **HLC (High Light Compensation) :**

This function masks the strong light to minimize white out due to over exposure and preserve much of the on-screen details when the camera aims a strong light source.

- LEVEL : Adjusts the brightness level of a monitoring area.
- LIMIT : Enable to change the operating condition.
- MASK COLOR /TONE :

Change the color / brightness of the masking area.

(Black, Red, Blue, Cyan, Magenta)

- TOP/BOTTOM/LEFT/RIGHT : Adjust the area to be enhanced.
- RETURN : Return to the MAIN SETUP menu.

HLC SETUP		
▶ 1. LEVEL		MIDDLE
2. LIMIT		NIGHT ONLY
3. MASK COLOR		BLACK
4. MASK TONE	-*-----	5
5. TOP	--*-----	30
6. BOTTOM	-----*--	75
7. LEFT	--*-----	30
8. RIGHT	-----*--	75
9. RETURN	↓	



- If the white balance menu is set to manual, then HLC performance can be limited.
- If you use the defog and HLC functions at the same time, saturation can occur in a bright environment.
- Because there can be a difference in the effectiveness of HLC according to the amount of light area in the screen, optimize the installation angle for the best HLC performance.
- When dark, the HLC is only activated when a bright light exceeding a specific size. (In NIGHT ONLY mode).
- The HLC is not activated in day light or when bright light is not present at night. (In NIGHT ONLY mode).

- **WDR :** When there are both bright and dark areas at the same time, this mode makes both areas distinctive.

- LEVEL : Select one from low, med, high to adjust the brightness of the WDR setup.

WDR SETUP	
▶ 1. LEVEL	MIDDLE
2. RETURN	↓



<WDR ON>



<WDR OFF>

- RETURN : Return to the MAIN SETUP menu.



- In WDR mode, the max/min shutter value is set to 1/2 to 1/240.
- In WDR mode, there can be noise between a bright and dark area.
- Depending on light conditions, unnatural changes or symptoms can occur on the screen so deactivate the user mode.

camera operation

SPECIAL

1. When the SETUP menu screen is displayed, select 'SPECIAL' by using the Function Setup switch so that the arrow indicates 'SPECIAL'.
2. Select a desired mode using the Function Setup switch.

• DISPLAY

- ① If the SPECIAL menu screen is displayed, use the Function Setup switch so that the arrow indicates 'DISPLAY'.
- ② Select a desired mode using the Function Setup switch.

- CAM TITLE

- ① If the DISPLAY menu screen is displayed, use the Function Setup switch so that the arrow indicates 'CAM TITLE'.
- ② Set it to 'ON' by using the Function Setup switch.
- ③ Press the Function Setup switch.
- ④ Use the Function Setup switch to move to a desired letter and select the letter by pressing the Function Setup switch. Repeat this to enter multiple letters. You can enter up to 15 letters.
- ⑤ Enter a title, move the cursor to 'POS' and press the Function Setup switch. The entered title appears on the screen. Select the position to display the title on the screen by using the Function Setup switch and press the Function Setup switch. When the position is determined, select 'END' and press the Function Setup switch to return to the DISPLAY menu.

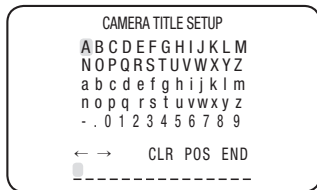
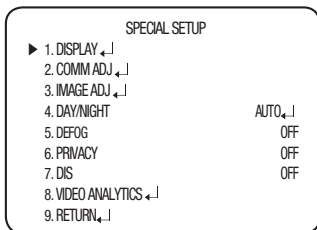

- When the CAM TITLE menu is 'OFF', no title will be displayed on the monitor screen even if you enter one.
- and Numbers are available in this mode.
- If you move the cursor to CLR and press the Function Setup switch, all the letters are deleted. To edit a letter, change the cursor to the bottom left arrow and press the Function Setup switch. Move the cursor over the letter to be edited, move the cursor to the letter to be inserted and then press the Function Setup switch.

- DISP ID : Display camera title on top left corner of the screen.
- FONT COLOR : You can change the OSD font color. (White, Yellow, Green, Red, Blue)
- LANGUAGE : You can select the menu language according to your requirements.
- RETURN : Return to the SPECIAL menu.

• COMM ADJ (Communication Adjustment) :

This function sets up the camera communication status when controlling the camera through an external control device.

- 1 If the SPECIAL menu screen is displayed, use the Function Setup switch so that the arrow indicates 'COMM ADJ'.

COMM SETUP		
▶ 1. PROTOCOL		SAMSUNG-T
2. CAM ID	*-----	1
3. BAUD RATE		9600
4. UART MODE		8-N-1
5. RET PKT		ENABLE
6. COAX		ON
7. RETURN	↵	

- 2 Select a desired mode using the Function Setup switch.

- PROTOCOL : Select the communication PROTOCOL.
(SAMSUNG-T, SAMSUNG-E, PELCO-D, PELCO-P, BOSCH, HONEYWELL, VICON, PANASONIC, GE and AD)
- CAM ID : Determines the camera's identification number (between 0 and 255).
- BAUD RATE : You can select 2400/4800/9600/19200/38400/57600 bps .
- UART MODE : You can select NONE, EVEN or ODD for the parity bits.
- RET PKT : Determines whether to send a command back to the controller device when a communication control command is sent to the camera.
- COAX : You can select whether to use COAX communication.
- RETURN : Return to the SPECIAL menu.

• IMAGE ADJ

- 1 If the SPECIAL menu screen is displayed, use the Function Setup switch so that the arrow indicates 'IMAGE ADJ'.

IMAGE SETUP		
▶ 1. GAMMA		0.45
2. PED LEVEL	----*----	50
3. COLOR GAIN	----*----	50
4. H-REV		OFF
5. V-REV		OFF
6. D-ZOOM		OFF
7. SHARPNESS		MIDDLE ↵
8. PFR		OFF
9. RETURN	↵	

- 2 Select a desired mode using the Function Setup switch.
- GAMMA : The setting range is 0.2 ~ 1.0. The closer to 1.0 the setting is, the darker it gets.

camera operation

- PED LEVEL : The setting range is 1 ~ 100. The closer to 100 the setting is, the higher the PED level gets.
- COLOR GAIN : The setting range is 1 ~ 100. The smaller the setting value is the smaller the color gain gets and the more color blind it gets.
- H-REV : Flip an image horizontally.
- V-REV : Flip an image vertically.
- D-ZOOM : You can use a digital zoom of x1 ~ x16.
- SHARPNESS : Select a mode to adjust the thickness of an image's sharpness. Increase or decrease the level of each mode to adjust the level of sharpness. Depending on the image, adjust it to an appropriate value. (OFF/LOW/MIDDLE/HIGH)
- PFR : Purple fringe can be reduced.
- RETURN : Return to the SPECIAL menu.



- When the V-REV or H-REV mode is enabled, the text on the screen does not flip.
- If you increase the SHARPNESS level too high, the picture may become distorted or noise may appear.
- When you use the PFR function, if there is an object near the strong light, the color can be missing.

- **DAY/NIGHT** : You can display pictures in color or in black and white.

- ① If the SPECIAL menu screen is displayed, use the Function Setup switch so that the arrow indicates 'DAY/NIGHT'.
- ② Select a desired mode using the Function Setup switch according to the picture display you want.

- **AUTO** : The mode is switched to 'Color' in a normal environment, but switches to 'B/W' mode when ambient illumination is low. To set up the switching time for AUTO mode, press the Function Setup switch. You can turn on or off the burst signal on B/W mode.

AUTO SETUP	
▶ 1. BURST MODE	ON
2. DURATION	NORMAL
3. DWELL TIME	30 SEC
4. RETURN ◀	

- **BURST MODE** : Activate or deactivate the burst mode to maintain or remove the color signal.

- **DURATION** : This function is used to select the brightness of light where switching occurs.

GAIN LEVEL	LOW		MID		HIGH	
	Color→B/W	B/W→Color	Color→B/W	B/W→Color	Color→B/W	B/W→Color
VERY SLOW	2.4	5.2	1.5	5.6	0.6	6.2
SLOW	2.5	5	1.8	5.4	1.1	6
NORMAL	2.6	4.9	2.1	5.2	1.6	5.8
FAST	2.7	4.8	2.4	5	2.1	5.4
VERY FAST	2.8	4.7	2.7	4.8	2.6	5

※ Depending on the installation environment and the exposure menu's gain mode setting, the switching brightness may vary.

- **DWELL TIME** : You can select day/night switching delay time from.
→ 3s, 5s, 7s, 10s, 15s, 20s, 30s, 40s, 60s



- If you set the AGC mode to off on the exposure menu, you cannot switch the day/night mode to auto.
- When a bright light source is in the screen or there are frequent brightness changes, if you use the auto night/day mode, and set the switching time to short (3, 5 sec), a hunting can be caused. In this situation, it is recommended to use the default setting (30 sec).

- **EXTERN** : Ground to the grounding terminal to allow automatic switching between COLOR and B/W (Black/White).
- **COLOR** : The picture is always displayed in color.
- **B/W** : The picture is always displayed in black and white.
You can turn on or off the burst signal on B/W mode.



- If the lens mounted in the camera is different from the one set in <LENS> of the <EXPOSURE> menu, then the night/day mode may not operate normally.

- **DEFOG** : You can use the defog mode to allow the camera to automatically detect the fog density of the screen and display a clear image despite smog, fog or general poor visibility.

① If the SPECIAL menu screen is displayed, use the Function Setup switch so that the arrow indicates 'DEFOG'.

② Select a desired mode using the Function Setup switch.

- **AUTO** : Adjust the level automatically.
- **Manual** : Depending on the defog level set by the user, adjust the clarity of image. (LOW, MIDDLE, HIGH)
- **OFF** : Released state

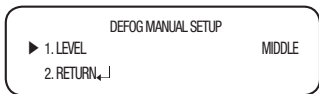

camera operation



- If the defog mode is set to Auto, and if the amount of fog is reduced, the function level will be also reduced. If you want to maintain the same level of defogging, set it to Manual.
- If there is little fog and the manual fog level is high, the screen contrast can get high.

- **PRIVACY** : Mask an area you want to hide on the screen.

- ① If the SPECIAL menu screen is displayed, use the Function Setup switch so that the arrow indicates 'PRIVACY'.
- ② Select a desired mode using the Function Setup switch.

- AREA : You can select up to 24 PRIVACY areas.
- MODE : Determines whether to use the area selected in the AREA.
- MASK COLOR : Determine area color. You can select Green, Red, Blue, Black, White, Gray.
- TRANSPARENCY : Adds or removes transparency from the masking area.
- SEL POS/ XPOS/ YPOS : Adjust the size and position of the selected area.
- RETURN : Return to the SPECIAL menu.

PRIVACY AREA SETUP		
▶ 1. AREA		AREA1
2. MODE		OFF
3. MASK COLOR		GREEN
4. TRANSPARENCY		OFF
5. SEL POS		L_TOP
6. X POS	*-----	18
7. Y POS	-*-----	33
8. RETURN	↵	

- **DIS (Digital Image Stabilizer)** : This function mitigates any picture movement due to external factors such as wind.

- **VIDEO ANALYTICS**

- ① If the SPECIAL menu screen is displayed, use the Function Setup switch so that the arrow indicates 'VIDEO ANALYTICS'.
- ② Select a desired mode using the Function Setup switch.

- TAMPERING : If the screen view is obstructed or the camera location is changed, tampering detection, you can issue an event signal by setting it.

VIDEO ANALYTICS		
▶ 1. TAMPERING		OFF
2. MOTION		OFF
3. INTELLIGENCE		OFF
4. RETURN	↵	

TAMPERING		
▶ 1. SENSITIVITY		MIDDLE
2. ALARM OUT	↵	
3. RETURN	↵	

- SENSITIVITY : Set the sensitivity to tampering detection.
- ALARM OUT : Outputting of detection signals can be set.
 - EXTERNAL : Send signals through external terminals.
 - OSD : Display signals on the screen.
 - RETURN : Return to the TAMPERING menu.
- RETURN : Return to the VIDEO ANALYTICS menu.



- In the following cases, the initially set tampering detection function can malfunction.
 - In a monitoring environment with a simple background or an environment with low light level or at night, the detection performance can deteriorate.
 - Sudden changes in the lighting and severe camera shaking can be wrongly detected as tampering.
 - Immediately after tampering, the camera tampering detection can take up to a max of five seconds.
 - If camera tampering is detected, after some time(five sec), stabilization will be done before restarting. During stabilization, there is no detection.

- MOTION : This product generates signals each time an object movement is detected in the four areas of the screen so efficient monitoring can be achieved.

MOTION DET	
▶ 1. DET. SIZE ◀↓	
2. DET. AREA ◀↓	
3. NON DET. AREA ◀↓	
4. INDICATOR	OFF
5. ALARM OUT ◀↓	
6. RETURN ◀↓	

- DET. SIZE : Selects an object size to detect on the screen.
- DET. AREA : Set the areas of motion detection.
 - SEL AREA : Select from four areas that users want.
 - MODE : Determine whether to use the selected area.

MOTION DETECT AREA		AREA1
▶ 1. SEL AREA		ON
2. MODE		ON
3. SENSITMITY	----*----	5
4. TOP	*-----	1
5. BOTTOM	-----*	100
6. LEFT	*-----	1
7. RIGHT	-----*	100
8. RETURN ◀↓		

- SENSITIVITY : Set the sensitivity of the motion detection. When you adjust the higher level, the more sensitive.
- TOP/BOTTOM/LEFT/RIGHT : Area location can be adjusted.
- RETURN : Return to the MOTION DET menu.

camera operation

- **NON DET. AREA** : Specify a detection exception area to mask. Select a mask area number and specify the size and position.
 - **SEL AREA** : You can select up to 4 areas.
 - **MODE** : Determines whether to use the area selected in the AREA.
 - **TOP/BOTTOM/LEFT/RIGHT** : Adjust the size and position of the selected area.
 - **RETURN** : Return to the MOTION DET menu.
- **INDICATOR** : If an object moves in a pattern set by the user, it will be displayed on the screen as a box.
- **ALARM OUT** : When object movement is detected, the detection signal will be outputted.
 - **EXTERNAL** : Send signals through external terminals.
 - **OSD** : Display signals on the screen.
 - **RETURN** : Return to the MOTION DET menu.
- **RETURN** : Return to the VIDEO ANALYTICS menu.
- **INTELLIGENCE** : Set the intelligent video detection function.
- **SENSITIVITY** : Set the sensitivity of the motion detection. When you adjust the higher level, the more sensitive.

INTELLIGENCE		
▶ 1. SENSITIVITY	----*----	5
2. DET. SIZE ◀		
3. FENCE ◀		
4. APPEAR ◀		
5. INDICATOR		OFF
6. ALARM OUT ◀		
7. RETURN ◀		

- **DET. SIZE** : Selects an object size to detect on the screen.
- **FENCE**

- **SEL FENCE** : You can select up to 4 FENCE.
- **MODE** : Determines whether to use the fence selected in the FENCE.
- **TYPE** : Two types, line and area, of fences are available.

VIRTUAL FENCE		
▶ 1. SEL FENCE		FENCE1
2. MODE		OFF
3. TYPE		LINE
4. POSITION ◀		
5. COUNT		OFF
6. RETURN ◀		

- **POSITION** : Defines the position and detection direction of a line or fenced area.

1) LINE FENCE

- SEL POS : Selects a position from POS1, POS2.
- X POS / Y POS : Adjust the size and position of the selected line fence.
- DIRECTION
 - RIGHT : Detects objects moving left to right on the fence line.
 - LEFT : Detects objects moving right to left on the fence line.
 - RIGHT/LEFT : Detects all objects moving crosswise on the fence line.
- RETURN : Return to the VIRTUAL FENCE menu.

LINE FENCE		
▶ 1. SEL POS		POS1
2. X POS	---*---	50
3. Y POS	*-----	1
4. DIRECTION		RIGHT
5. RETURN ↵		

2) AREA FENCE

- SEL POS : Selects a position from POS1 ~ POS4.
 - X POS / Y POS : Adjust the size and position of the selected area fence.
 - DIRECTION
 - IN : Detects objects entering the fenced area.
 - OUT : Detects objects exiting the fenced area.
 - IN/OUT : Detects all objects entering and exiting the fenced area.
 - RETURN : Return to the VIRTUAL FENCE menu.
 - COUNT : Displays how many times a subject passes over the fence on the screen.
 - RETURN : Return to the INTELLIGENCE menu.
 - APPEAR : Detects an object that emerges or disappears from the screen, or stays onscreen without movement.
 - INDICATOR : Outlines an object on the screen in a box when its movement matches a custom Motion Type.
- 
 In the following cases, the appear/indicator may malfunction.
 - When multiple movements occur randomly
 - When a fixed object keeps moving in the same location
 - When a new object covers an object with changes

AREA FENCE		
▶ 1. SEL POS		POS1
2. X POS	--*-----	25
3. Y POS	--*-----	25
4. DIRECTION		IN
5. RETURN ↵		

camera operation

- ALARM OUT : When object movement is detected, the detection signal will be outputted.
 - EXTERNAL : Send signals through external terminals.
 - OSD : Display signals on the screen.
 - RETURN : Return to the INTELLIGENCE menu.
- RETURN : Return to the VIDEO ANALYTICS menu.



- Before use, set the max/min movement size within the range.
- Depending on the shape of an object, there can be errors in size detection.
- From the top of the screen, a max of sixteen objects can be expressed.
- If the camera shoots an object a short distance away, the video analysis function can be degraded.
- In the following cases, motion detection or video analysis event performance can be degraded or malfunctions can occur.
 - If an object's brightness or color is similar to that of the background
 - If there is little movement near the screen edge
 - If multiple movements keeps occurring randomly, such as scene switching or sudden light changes
 - If an object fixed in the same location keeps moving
 - Moving away from the camera or approaching the camera. Little location change on the screen.
 - If a moving object approaches the camera
 - If random objects obstruct the view of each other
 - If more than one objects merge or one object divides into multiple objects
 - If an object moves too fast (the same object should have overlapping areas between the consecutive frames)
 - If there are reflections/blurs/shadows created by a strong light such as direct sunlight, lights, and headlights.
 - Severe snow, rain and wind. Sunset or sunrise
 - If the size is greater than the max size or smaller than the min size, motion is not detected. To avoid false detection caused by noises, set the max/min detection size suitable for the installation environment.
But the same movement in the same location can cause a different detection size. So, include margins when you set the min/max detection size.

EXIT

Select a desired EXIT mode using the Function Setup switch depending on the camera purpose.

- **SAVE** : Save the current settings and exit the MAIN SETUP menu.
- **NOT SAVE** : Do not save the current settings and exit the MAIN SETUP menu.
- **RESET** : Revert camera to factory settings. (The language, communication and lens settings will remain the same).

Troubleshooting

If you have trouble operating your camera, refer to the following table.

If the guidelines do not enable you to solve the problem, contact an authorized technician.

Problems	Troubleshooting
Nothing appears on the screen.	<ul style="list-style-type: none">• Check that the power cord and line connection between the camera and monitor are properly connected.• Check that you have properly connected BNC cable to the camera.• Check the type of lens.
The image on the screen is dim.	<ul style="list-style-type: none">• Is lens stained with dirt? Clean your lens with soft, clean cloth.• Set the monitor or DVR to the proper condition.• If the camera is exposed to very strong light, change the camera position.
The image on the screen is dark.	<ul style="list-style-type: none">• Adjust the contrast feature of the monitor or DVR.• If you have an intermediate device, set the 75Ω / Hi-z properly.
The camera is not working properly, and the surface of the camera is hot.	<ul style="list-style-type: none">• Check that you have properly connected the camera to an appropriate power source.
he DAY/NIGHT menu does not work.	<ul style="list-style-type: none">• Check that AGC of EXPOSURE SETUP menu is 'OFF'.
The INTELLIGENCE function does not work.	<ul style="list-style-type: none">• Check that INTELLIGENCE of menu is 'OFF'.
Color is not correct.	<ul style="list-style-type: none">• Check the setting of WHITE BAL SETUP menu
The screen flickers continually.	<ul style="list-style-type: none">• Ensure the camera is not pointing towards the sun.
When coaxial communication is not available	<ul style="list-style-type: none">• Make sure that the camera and monitor are installed within the recommended distance.• Use the video amplifier equivalent to coaxitron if the recommended installation distance is exceeded.

SPECIFICATIONS

	SCB-5003N	SCB-5003P
Video		
Imaging Device	1/3" 1.3M CMOS	
Total Pixels	1312(H) x 1069(V)	
Effective Pixels	1305(H) x 1049(V)	
Scanning System	Progressive Scan	
Synchronization	Internal	
Frequency	H : 15.734KHz / V : 59.94Hz	H : 15.625KHz / V : 50Hz
Horizontal Resolution	Color : 1000 TVL B/W : 1000 TVL	
Min. Illumination	Color : 0.03Lux (F1.2, 50IRE), 0.001Lux (1sec, F1.2, 50IRE) 0.01Lux (F1.2, 30IRE), 0.0003Lux (1sec, F1.2, 30IRE) B/W : 0.003Lux (F1.2, 50IRE), 0.0001Lux (1sec, F1.2, 50IRE) 0.001Lux (F1.2, 30IRE), 0.00003Lux (1sec, F1.2, 30IRE)	
S / N Ratio	52dB (AGC off, Weight on)	
Video Output	CVBS : 1.0 Vp-p / 75Ω composite	
Lens Type		
Focus Control	Manual	
Lens Type	Manual / DC Auto Iris / Video IRIS	
Mount Type	C/CS	
Operational		
On Screen Display	English, Chinese, Korean, Japanese, German, Italian, French, Spanish, Russian, Czech, Polish, Romanian, Serbian, Swedish, Danish, Turkish, Portuguese	
Camera Title	Off / On (Displayed 15 characters)	
Day & Night	Auto (ICR) / External / Color / B/W	
Backlight Compensation	Off / User BLC / HLC / WDR	
Wide Dynamic Range	120dB	
Contrast Enhancement	SSDR (Off / On)	
Digital Noise Reduction	SSNR4 (Off / On)	
Defog	AUTO / MANUAL / OFF	
Purple Fringe Reduction	Purple Fringe Reduction (Off / Low / Middle / High)	

specifications

	SCB-5003N	SCB-5003P
Digital Image Stabilization	Off / On	
Tampering	Off / On	
Motion Detection	Off / On	
Intelligent Video	Fence, Apear_Disappear, Counting (Off / On)	
Privacy Masking	Off / On (24 programmable zones with 4points polygonal masking)	
Gain Control	Off / Low / Middle / High	
White Balance	ATW / Outdoor / Indoor / Manual / AWC / MERCURY (1,800K° ~ 10,500K°)	
Electronic Shutter Speed	1 sec ~ 1/12,000 sec	
Digital Zoom	Off / On (1x ~ 16x)	
Reverse	Off / H-Rev / V-Rev / HV-Rev	
Profile	Basic, Day & Night, Backlight, ITS, Indoor, User	
Alarm	1 Out	
Communication	Coaxial Control (SPC-300 Compatible), RS-485	
Protocol	Coax : Pelco-C (Coaxitron) RS-485: Samsung-T, Samsung-E, Pelco-D, Pelco-P, Panasonic, Bosch, Honeywell, Vicon, AD, GE	
Environmental		
Operating Temperature / Humidity	-10°C ~ +55°C / Less than 90% RH	
Electrical		
Input Voltage	Dual (24VAC±10% & 12VDC±10%)	
Power Consumption	Max. 6.0W	
Mechanical		
Color / Material	Black, Ivory / Aluminum, Plastic	
Dimension (WxHxD)	68.4 x 59.6 x 92.7mm	
Weight	210g	

※ The specification for this product may change without prior notice for product improvement.

DIMENSION

Unit: mm

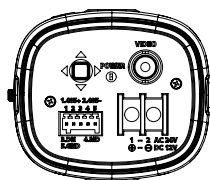
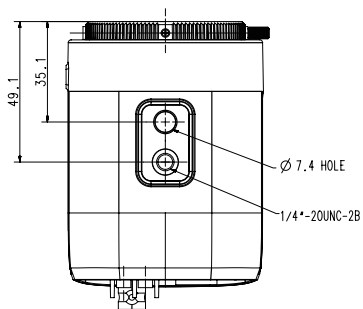
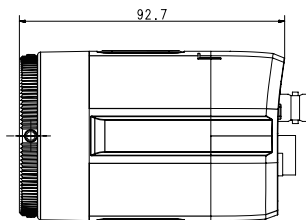
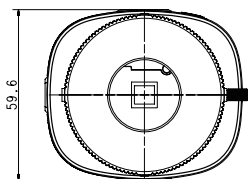

MEMO



SALES NETWORK

SAMSUNG TECHWIN CO., LTD.

Samsung Techwin R&D Center, 6, Pangyo-ro 319beon-gil, Bundang-gu, Songnam-si, Gyeonggi-do 463-400, Korea
TEL : +82-70-7147-8740-60, FAX : +82-31-8018-3745

SAMSUNG TECHWIN AMERICA Inc.

100 Challenger Rd. Suite 700 Ridgefield Park, NJ 07660
Toll Free : +1-877-213-1222 Direct : +1-201-325-6920
Fax : +1-201-373-0124
www.samsungcctvusa.com

SAMSUNG TECHWIN EUROPE LTD.

Samsung House, 1000 Hillswood Drive, Hillswood Business Park
Chertsey, Surrey, UNITED KINGDOM KT16 0PS
TEL : +44-1932-45-5300, FAX : +44-1932-45-5325

www.samsungtechwin.com

www.samsungsecurity.com